

Casing

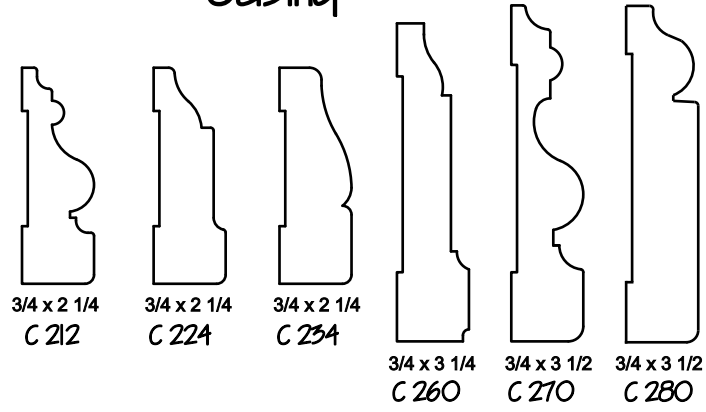

Chair rail

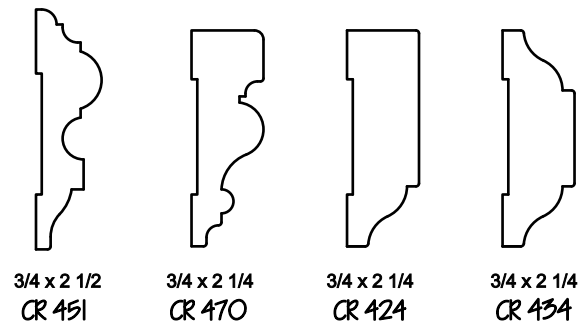

Crown

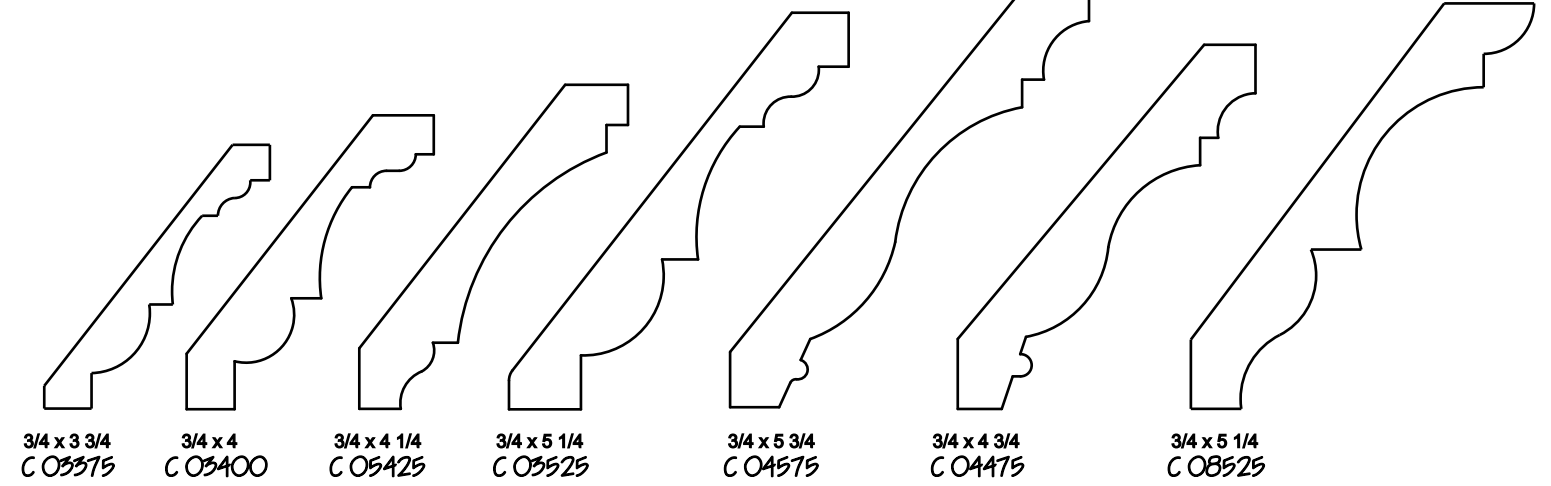

Panel Mold

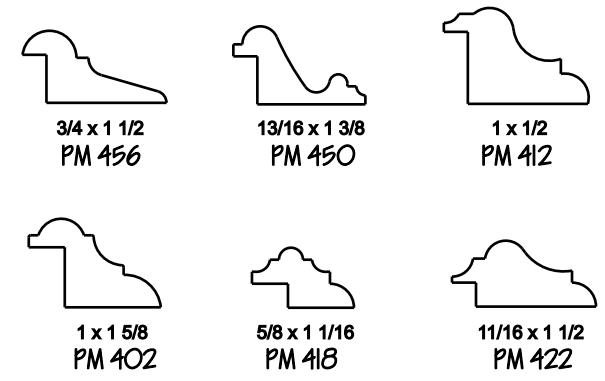

Plant-on

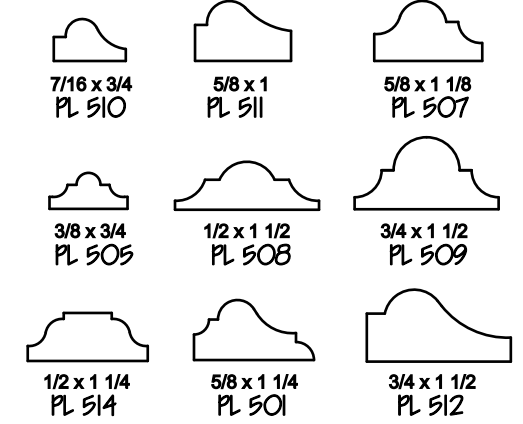

Cornice

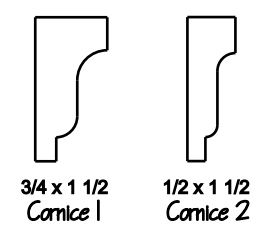

Crown

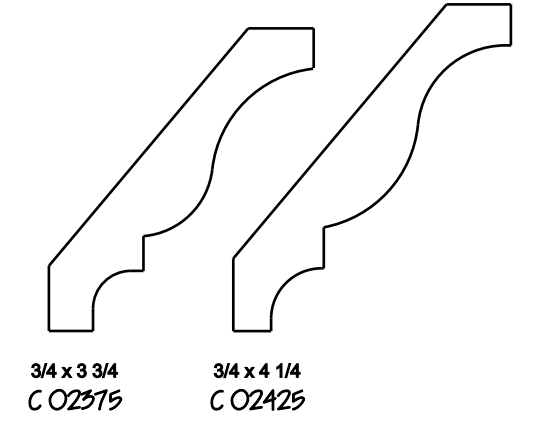

Base

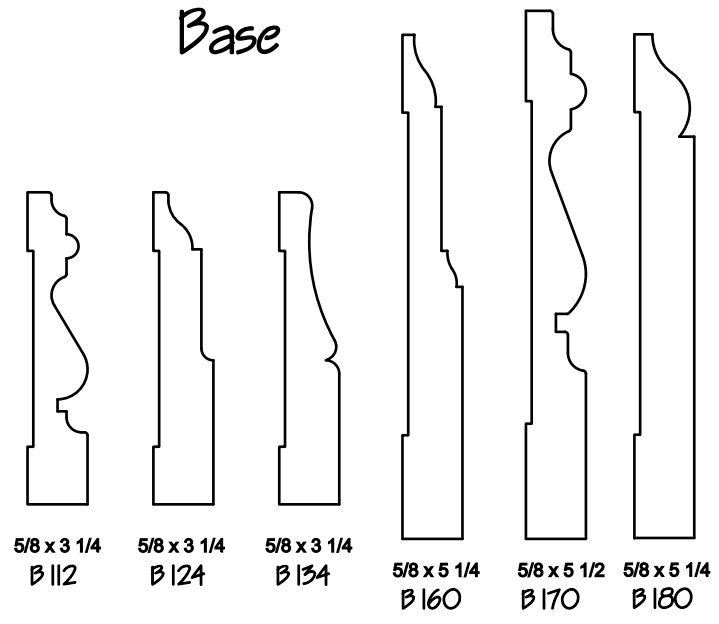

Stop



Bed Moulding

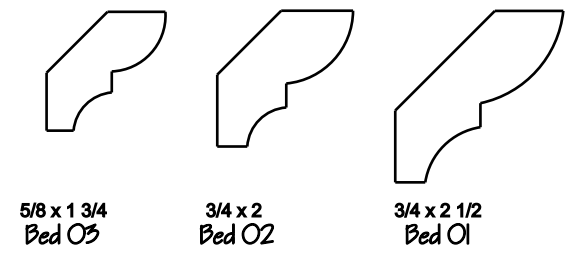

Symmetrical

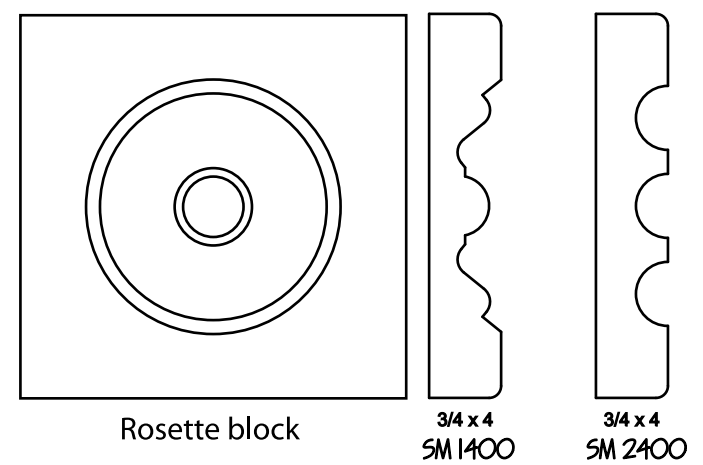

Dentil

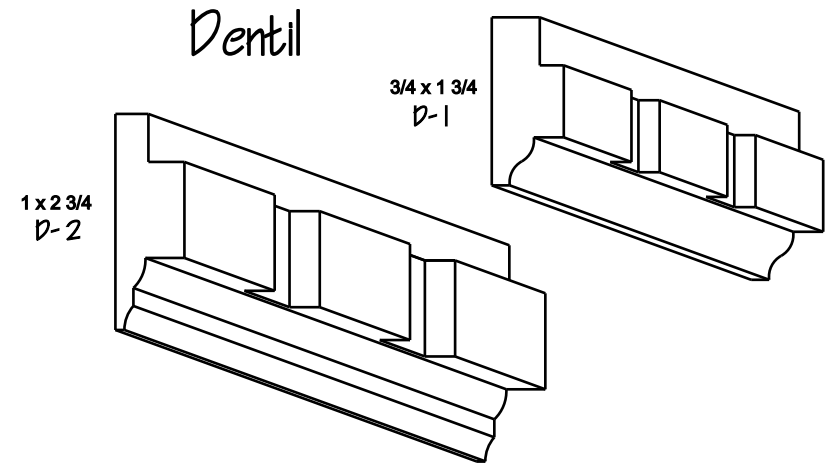

Cove Mould

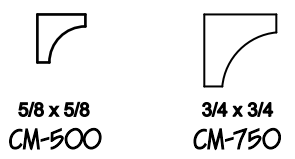

Nosing

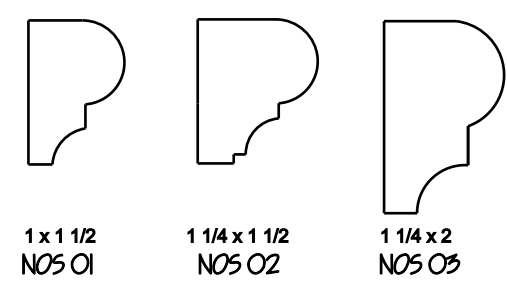

Quarter Rounds

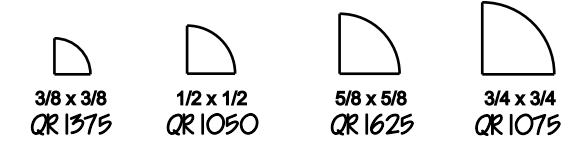

SAS
Varies

